

Einbauanleitung / Mounting Instruction E0-01-03 DE-EN

für Küffner Aluminiumzarge Typ UNF-UST | USTN-UNFN | URS-URF
for Küffner Aluminium Frame Type UNF-UST | USTN-UNFN | URS-URF

UNF - UST

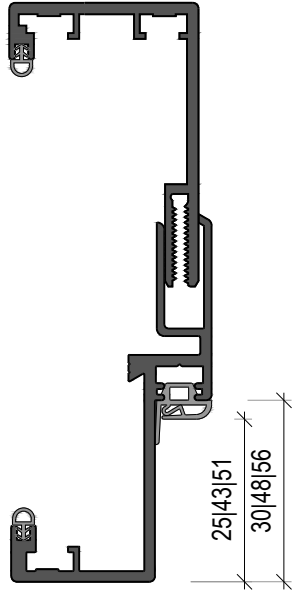

UNFN - USTN

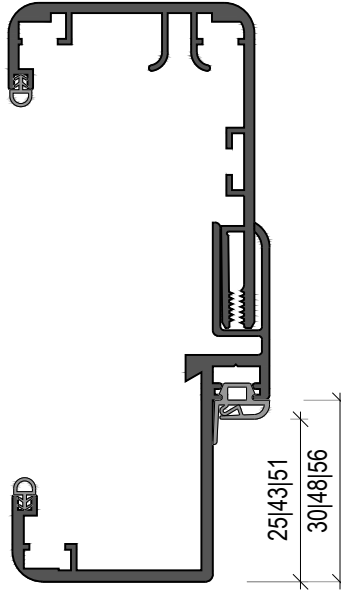

URS - URF

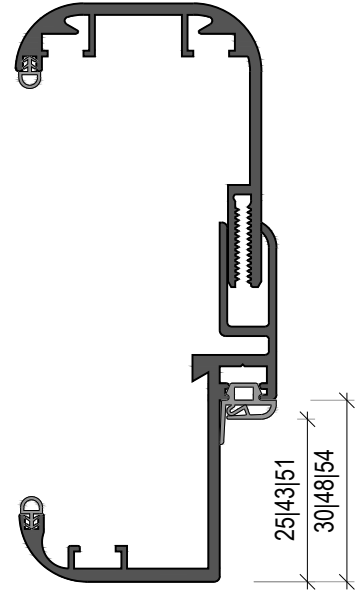

für Küffner Aluminiumzarge Typ UNF-UST | USTN-UNFN | URS-URF
for Küffner Aluminium Frame Type UNF-UST | USTN-UNFN | URS-URF

z.B. Aluminiumzarge UST
e.g. Aluminium Frame UST

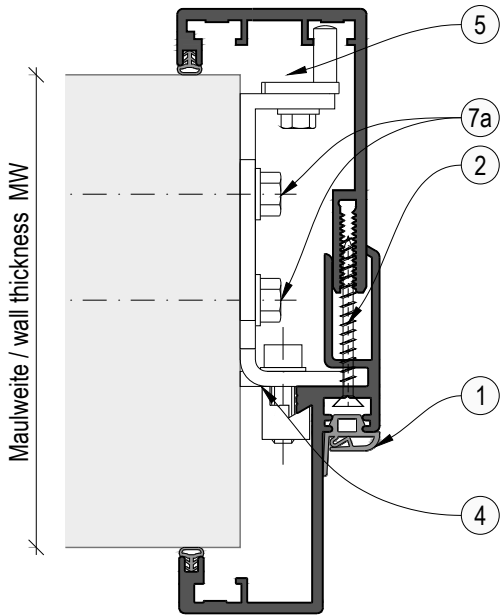

z.B. Aluminiumzarge UST mit Grundzarge
e.g. Aluminium Frame UST with Sub Frame

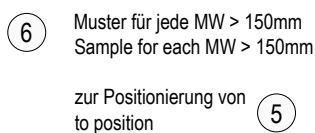
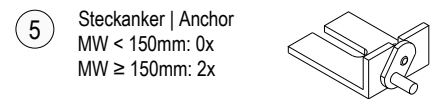
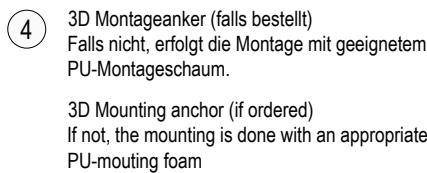
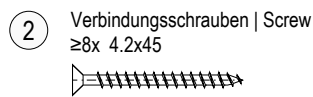
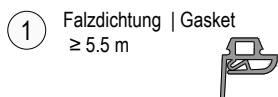
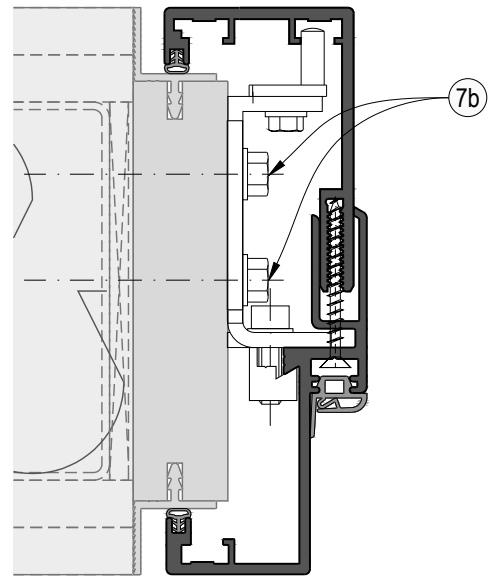

Befestigungsmittel **bauseits** z.B.: | fasteners **on site** e.g.:

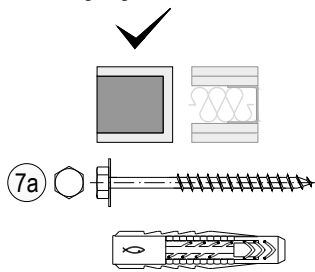

Sechskantkopf-Schraube mit Unterlegscheibe oder
Bund in passender Länge (mind. Ø 5.0mm) und
geeignetem Dübel.
Hexagon head screw with washer or collar in
suitable length (min Ø 5.0mm) and suitable dowels.

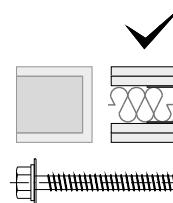

Selbstbohrende Sechskantkopf-Schraube mit Unterlegscheibe
oder Bund in passender Länge (mind. Ø 4.8mm)
Self drilling hexagon head screw with washer or collar (min. Ø
4.8mm)

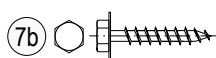

Sechskantkopf-Schraube mit Unterlegscheibe oder Bund (5x30mm)
Hexagon head screw with washer or collar (5x30mm)



für Küffner Aluminiumzarge Typ UNF-UST | USTN-UNFN | URS-URF
for Küffner Aluminium Frame Type UNF-UST | USTN-UNFN | URS-URF

3D Montageart mit 3D-Anker
Mounting method with 3D-Anchor

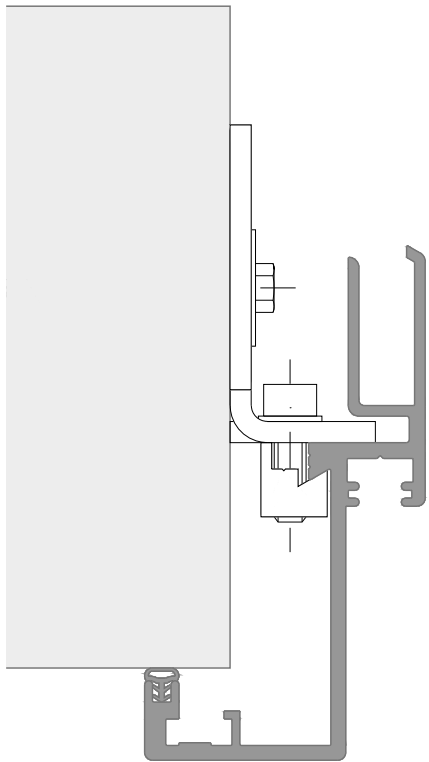

PUR Montageart mit 2K PUR Montageschaum
Mounting method with 2K PUR assembly foam

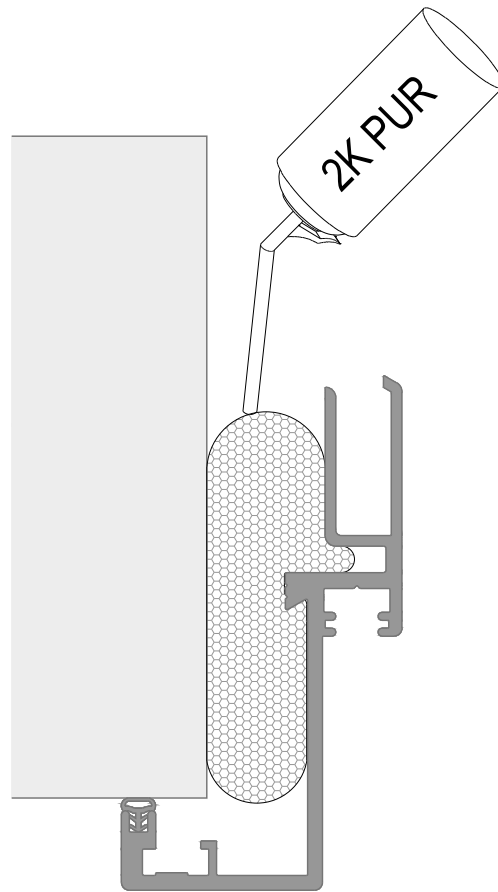

Zargen werden je nach Bestellung entweder mit oder ohne 3D-Anker ausgeliefert
Bis zu einem Türblattgewicht von max. 60kg können die Zargen mit geeignetem PU-Montageschaum befestigt werden.

Depending on the order door frames will be delivered either with or without 3D-anchor.
If the door weight is less than 60kg, the frame can be mounted with an appropriate PU mounting foam.

Einbauanleitung / Mounting Instruction E0-01-03 DE-EN

für Küffner Aluminiumzarge Typ UNF-UST | USTN-UNFN | URS-URF
for Küffner Aluminium Frame Type UNF-UST | USTN-UNFN | URS-URF

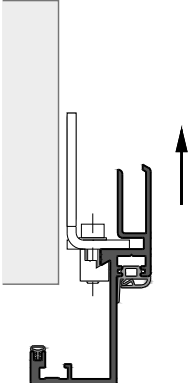
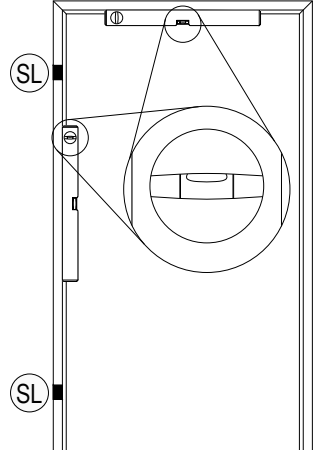
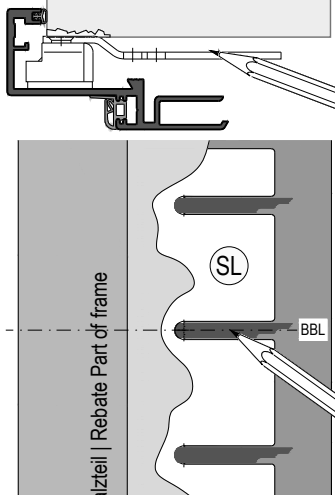
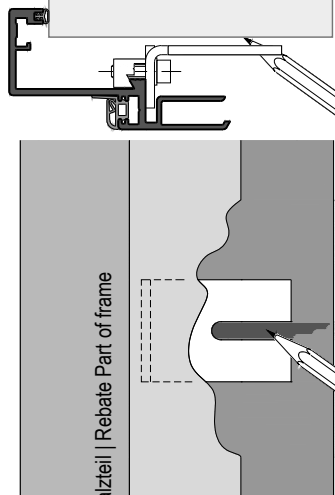
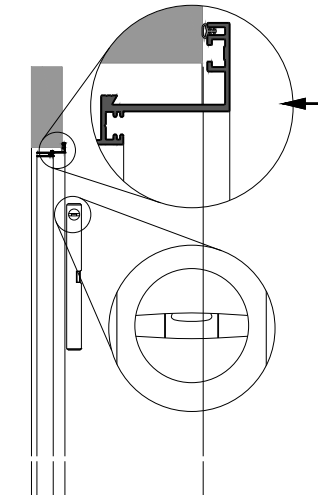
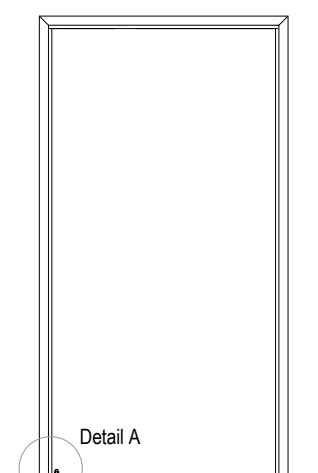
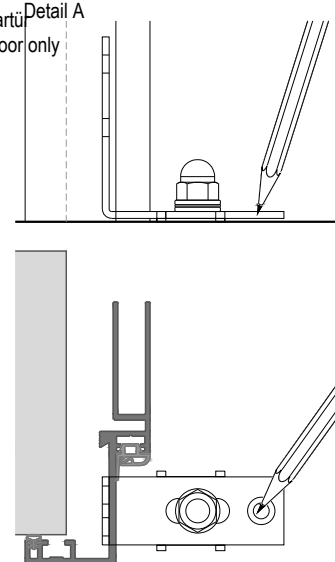
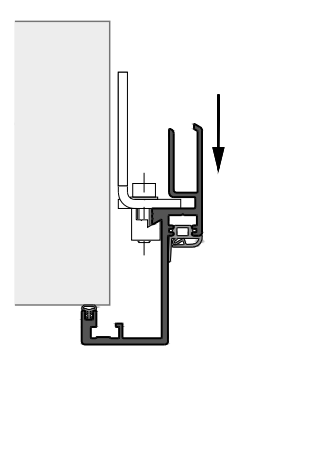
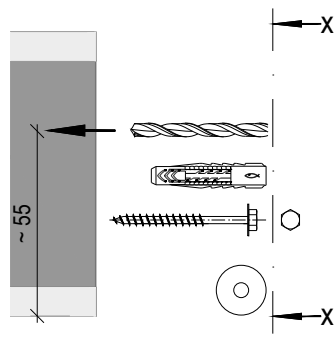
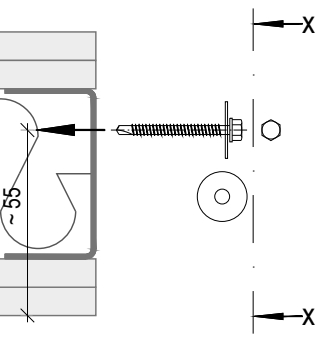
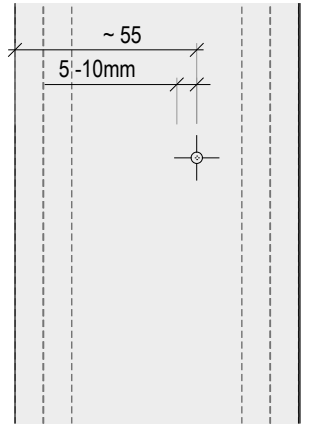
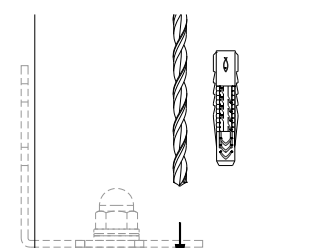
<p>01 3D PUR</p> 	<p>02 3D PUR</p> <p>Wenn Stahllaschen an Bändern oder in Kombination mit Raumspartür Only if steel plates on the hinge receiver or in Kombination with Space-Saving-Door</p> 	<p>03 3D PUR</p> <p>Wenn so geliefert When delivered like this</p>  <p>Falzteil Rebate Part of frame</p>	<p>04 3D PUR</p>  <p>Falzteil Rebate Part of frame</p>
<p>05 3D PUR</p> <p>Nur in Kombination mit Raumspartür In combination with Space-Saving-Door only</p> 	<p>06 3D PUR</p> <p>Nur in Kombination mit Raumspartür In combination with Space-Saving-Door only</p>  <p>Detail A</p>	<p>07 3D PUR</p>  <p>Detail A</p>	<p>07 3D PUR</p> 
<p>08.1 3D PUR</p> <p>Massivwand Solid wall</p>  <p>~55</p>	<p>08.2 3D PUR</p> <p>Trockenbauwand Drywall</p>  <p>~55</p>	<p>Ansicht / View x - x</p>  <p>~55 5-10mm</p>	<p>09 3D PUR</p> <p>Nur in Kombination mit Raumspartür In combination with Space Saving Door only</p>  <ul style="list-style-type: none"> • Bohrtiefe wegen eventueller Fußbodenheizung beachten. • Geeignete Dübel oder Chemiedübel verwenden. • Consider drilling depth due to possible in-floor heating. • Use suitable dowels or chemical dowels.

Einbauanleitung / Mounting Instruction E0-01-03 DE-EN

für Küffner Aluminiumzarge Typ UNF-UST | USTN-UNFN | URS-URF
for Küffner Aluminium Frame Type UNF-UST | USTN-UNFN | URS-URF

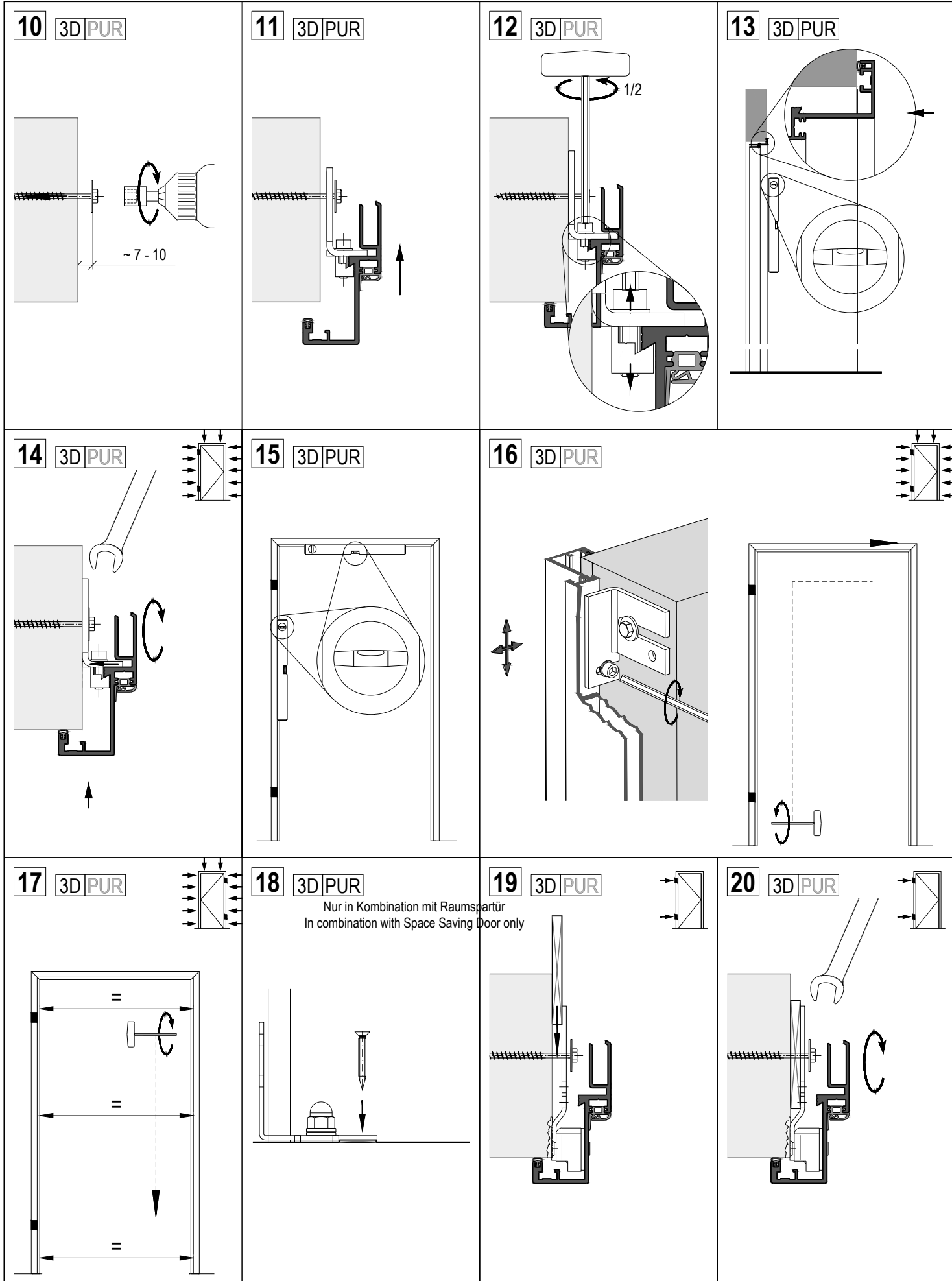

für Küffner Aluminiumzarge Typ UNF-UST | USTN-UNFN | URS-URF
for Küffner Aluminium Frame Type UNF-UST | USTN-UNFN | URS-URF

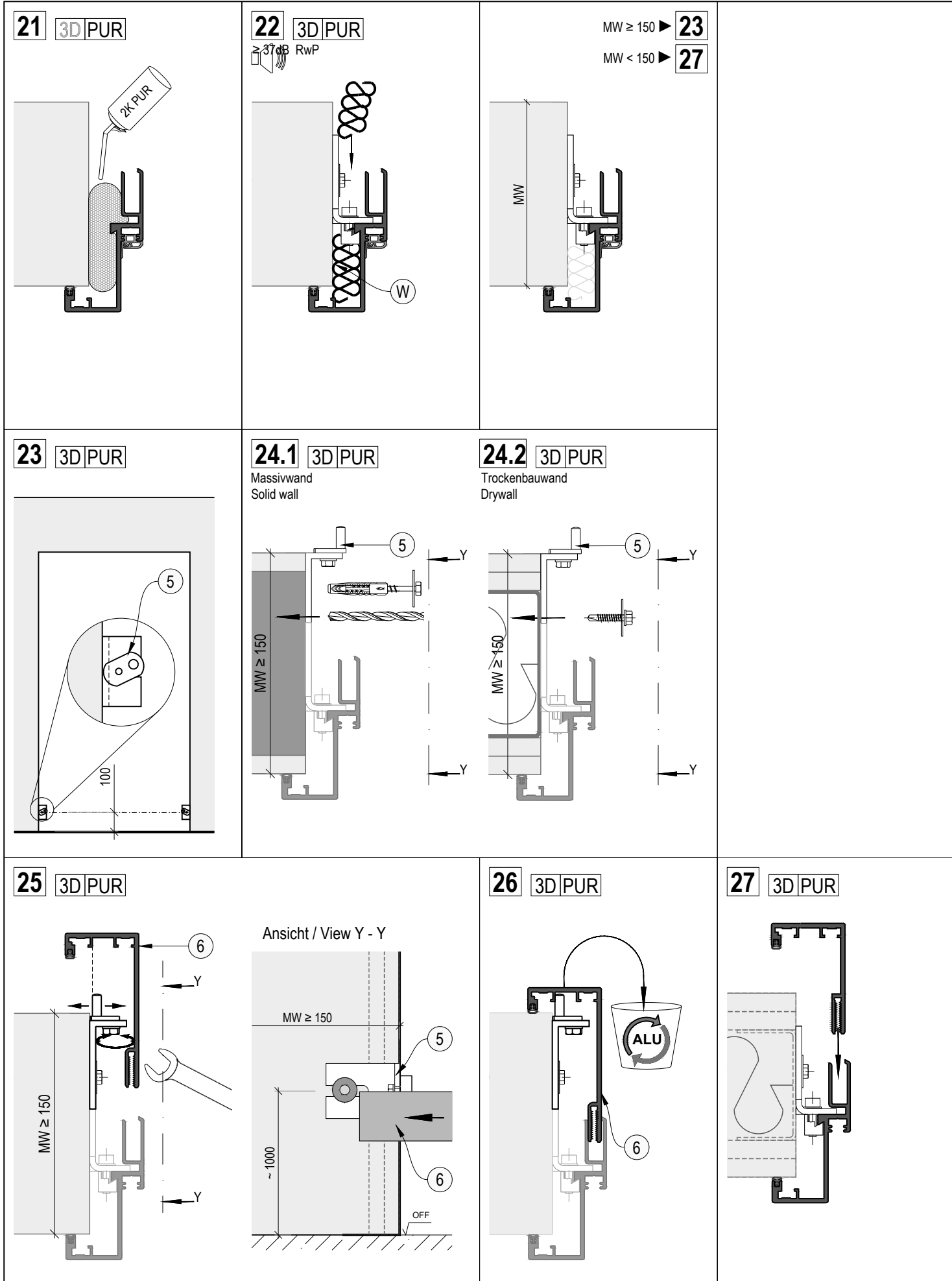

Einbauanleitung / Mounting Instruction E0-01-03 DE-EN

für Küffner Aluminiumzarge Typ UNF-UST | USTN-UNFN | URS-URF
for Küffner Aluminium Frame Type UNF-UST | USTN-UNFN | URS-URF

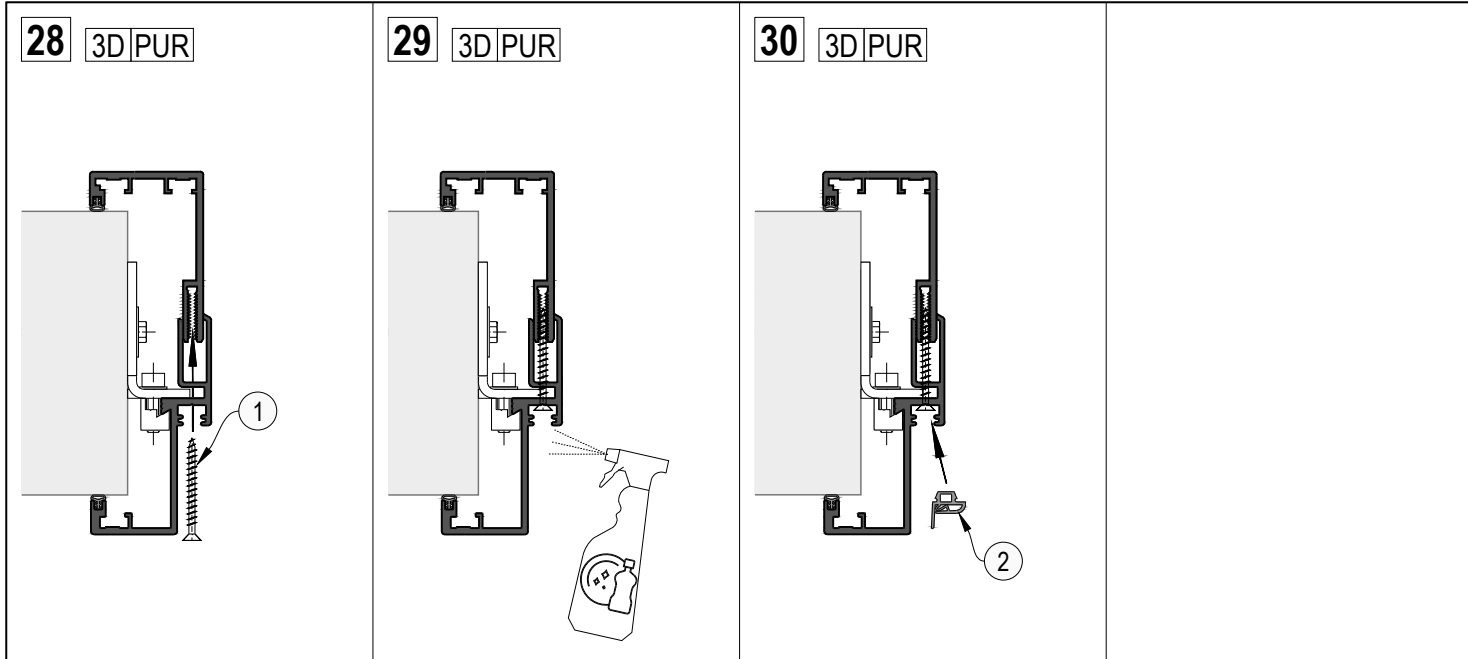

Einbauanleitung / Mounting Instruction E0-01-03 DE-EN

für Küffner Aluminiumzarge Typ UNF-UST | USTN-UNFN | URS-URF
for Küffner Aluminium Frame Type UNF-UST | USTN-UNFN | URS-URF

