

Einbauanleitung / Mounting Instruction E0-01-03 DE-EN

für Küffner Aluminiumzarge Typ UNF-UST | USTN-UNFN | URS-URF
for Küffner Aluminium Frame Type UNF-UST | USTN-UNFN | URS-URF

UNF - UST

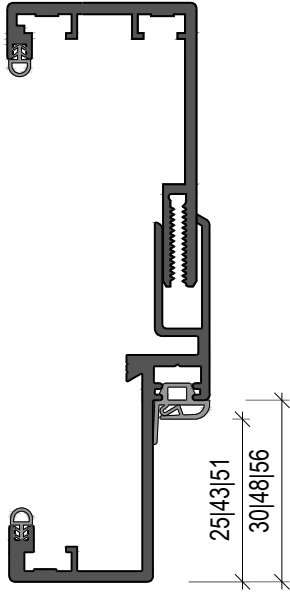

UNFN - USTN

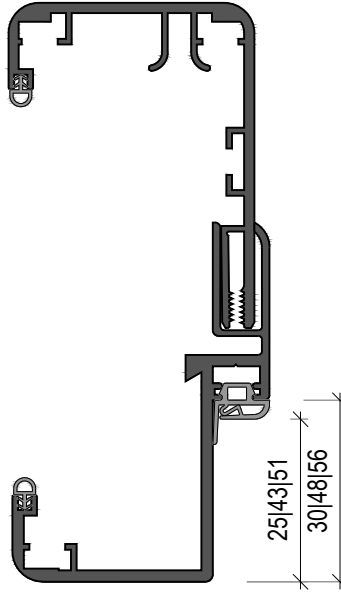

URS - URF

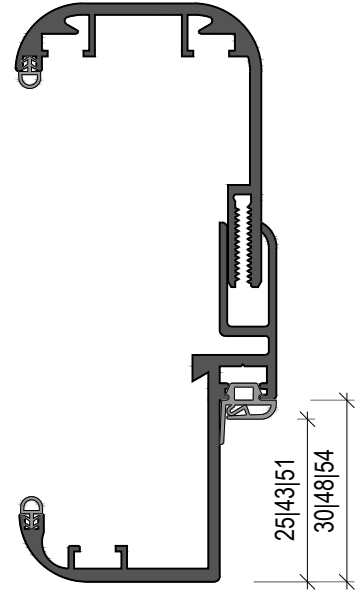

für Küffner Aluminiumzarge Typ UNF-UST | USTN-UNFN | URS-URF
for Küffner Aluminium Frame Type UNF-UST | USTN-UNFN | URS-URF

z.B. Aluminiumzarge UST
e.g. Aluminium Frame UST

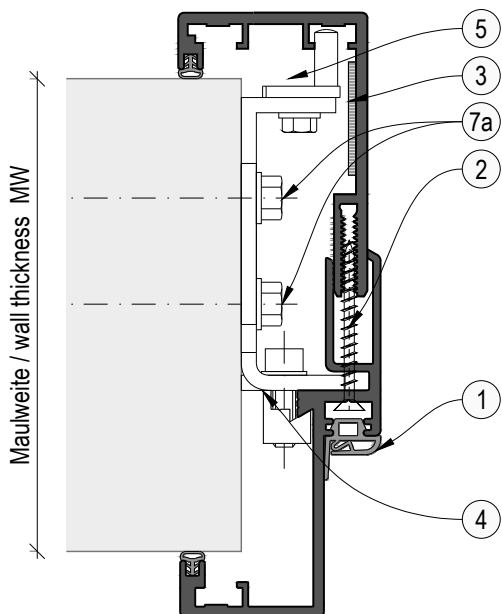

z.B. Aluminiumzarge UST mit Grundzarge
e.g. Aluminium Frame UST with Sub Frame

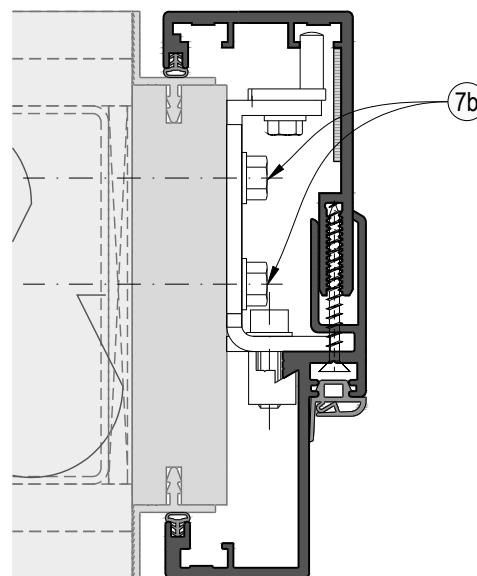

① Falzdichtung | Gasket
≥ 5.5 m



② Verbindungsschrauben | Screw
≥8x 4.2x45

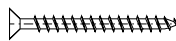

③ Antidröhnstreifen | Sound absorber strips 5 x 1000x35mm, MW ≥ 150mm:



④ 3D Montageanker (falls bestellt)
Falls nicht, erfolgt die Montage mit geeignetem PU-Montageschaum.
3D Mounting anchor (if ordered)
If not, the mounting is done with an appropriate PU-mounting foam

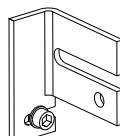

⑤ Steckanker | Anchor
MW < 150mm: 0x
MW ≥ 150mm: 2x

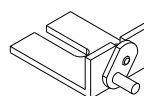



⑥ Muster für jede MW > 150mm
Sample for each MW > 150mm
zur Positionierung von ⑤
to position

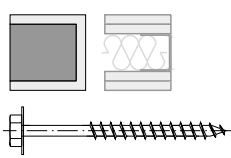

Befestigungsmittel **bauseits** z.B.: | fasteners **on site** e.g.:

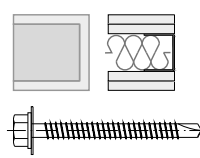
⑦a  Sechskantkopf-Schraube mit Unterlegscheibe oder Bund in passender Länge (mind. Ø 5.0mm) und geeignetem Dübel.
Hexagon head screw with washer or collar in suitable length (min Ø 5.0mm) and suitable dowels.

⑦b  Selbstbohrende Sechskantkopf-Schraube mit Unterlegscheibe oder Bund in passender Länge (mind. Ø 4.8mm)
Self drilling hexagon head screw with washer or collar (min. Ø 4.8mm)

⑦b  Sechskantkopf-Schraube mit Unterlegscheibe oder Bund (5x30mm)
Hexagon head screw with washer or collar(5x30mm)

W Mineralwolle, wenn
Mineral Wool, if  ≥ 37dB RwP 

für Küffner Aluminiumzarge Typ UNF-UST | USTN-UNFN | URS-URF
for Küffner Aluminium Frame Type UNF-UST | USTN-UNFN | URS-URF

3D Montageart mit 3D-Anker
Mounting method with 3D-Anchor

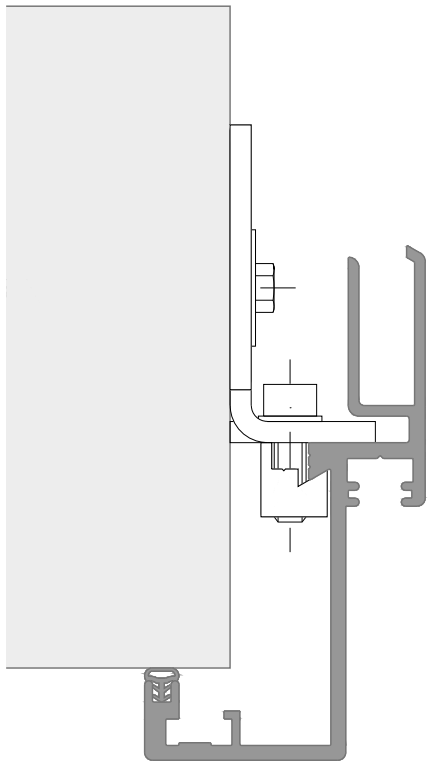

PUR Montageart mit 2K PUR Montageschaum
Mounting method with 2K PUR assembly foam

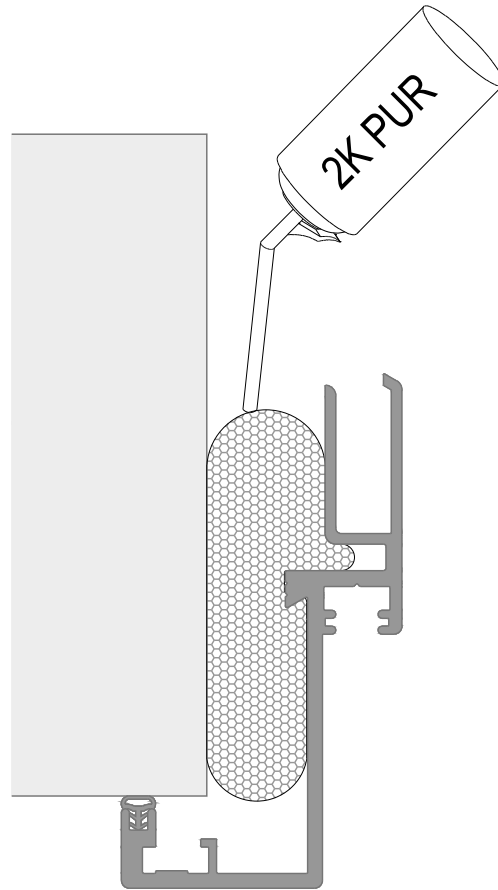

Zargen werden je nach Bestellung entweder mit oder ohne 3D-Anker ausgeliefert
Bis zu einem Türblattgewicht von max. 60kg können die Zargen mit geeignetem PU-Montageschaum befestigt werden.

Depending on the order door frames will be delivered either with or without 3D-anchor.
If the door weight is less than 60kg, the frame can be mounted with an appropriate PU mounting foam.

für Küffner Aluminiumzarge Typ UNF-UST | USTN-UNFN | URS-URF
for Küffner Aluminium Frame Type UNF-UST | USTN-UNFN | URS-URF

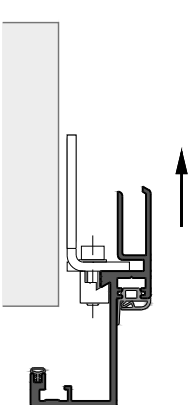
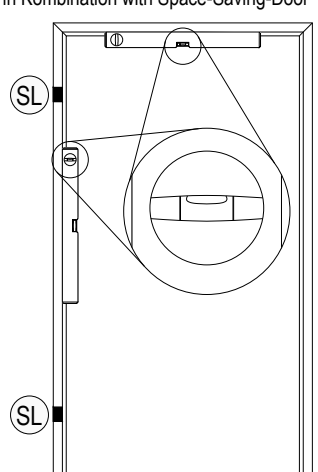
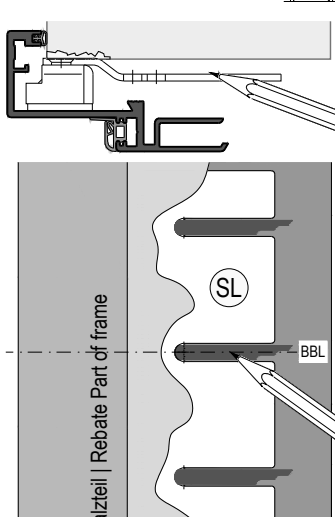
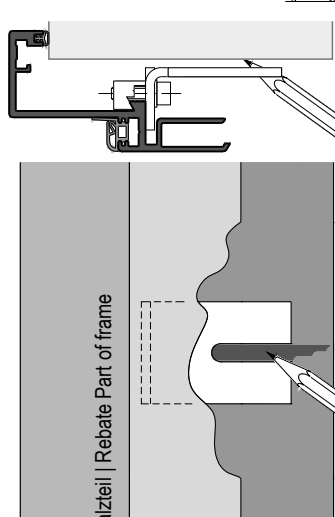
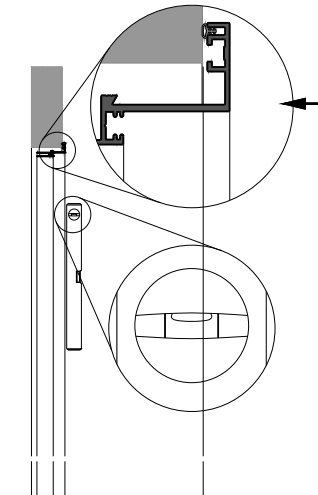
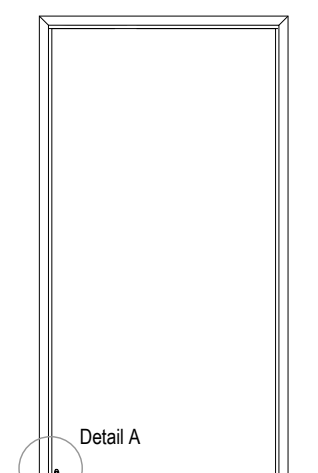
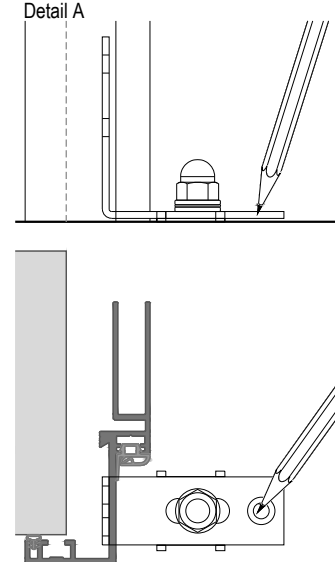
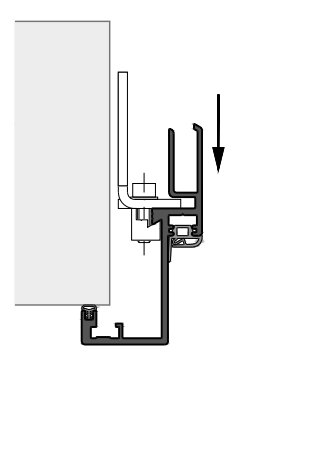
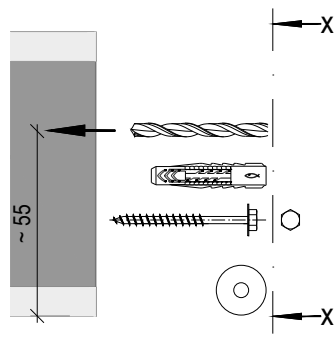
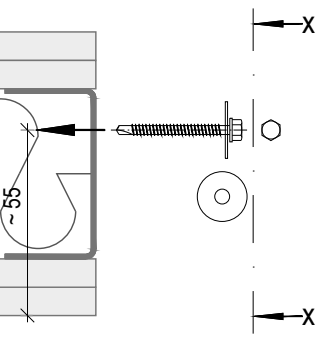
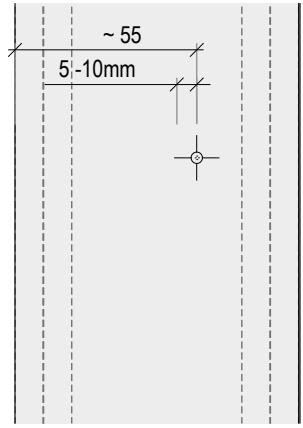
<p>01 3D PUR</p> 	<p>02 3D PUR</p> <p>Wenn Stahllaschen an Bändern oder in Kombination mit Raumspartür Only if steel plates on the hinge receiver or in Kombination with Space-Saving-Door</p> 	<p>03 3D PUR</p> <p>Wenn so geliefert When delivered like this</p>  <p>Falzteil Rebate Part of frame</p>	<p>04 3D PUR</p>  <p>Falzteil Rebate Part of frame</p>
<p>05 3D PUR</p> <p>Nur in Kombination mit Raumspartür In combination with Space-Saving-Door only</p> 	<p>06 3D PUR</p> <p>Nur in Kombination mit Raumspartür In combination with Space-Saving-Door only</p>  <p>Detail A</p>	<p>Detail A</p> 	<p>07 3D PUR</p> 
<p>08.1 3D PUR</p> <p>Massivwand Solid wall</p> 	<p>08.2 3D PUR</p> <p>Trockenbauwand Drywall</p> 	<p>09 3D PUR</p> <p>Nur in Kombination mit Raumspartür In combination with Space Saving Door only</p> <p>Ansicht / View x - x</p>  <ul style="list-style-type: none"> • Bohrtiefe wegen eventueller Fußbodenheizung beachten. • Geeignete Dübel oder Chemiedübel verwenden. • Consider drilling depth due to possible in-floor heating. • Use suitable dowels or chemical dowels. 	

Einbauanleitung / Mounting Instruction E0-01-03 DE-EN

für Küffner Aluminiumzarge Typ UNF-UST | USTN-UNFN | URS-URF
for Küffner Aluminium Frame Type UNF-UST | USTN-UNFN | URS-URF

<p>10 3D PUR</p> <p>~ 7 - 10</p>	<p>11 3D PUR</p>	<p>12 3D PUR</p> <p>1/2</p>	<p>13 3D PUR</p>
<p>14 3D PUR</p>	<p>15 3D PUR</p>	<p>16 3D PUR</p>	
<p>17 3D PUR</p>	<p>18 3D PUR</p> <p>Nur in Kombination mit Raumspartür In combination with Space Saving Door only</p>	<p>19 3D PUR</p>	<p>20 3D PUR</p>

Einbauanleitung / Mounting Instruction E0-01-03 DE-EN

für Küffner Aluminiumzarge Typ UNF-UST | USTN-UNFN | URS-URF
for Küffner Aluminium Frame Type UNF-UST | USTN-UNFN | URS-URF

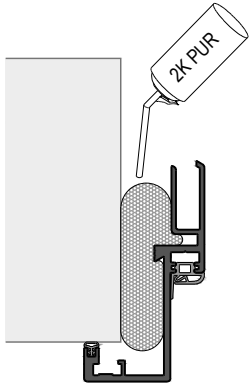
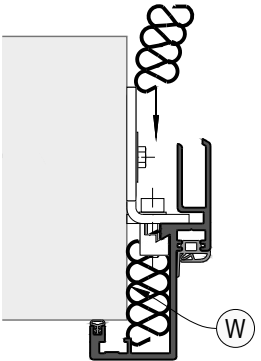
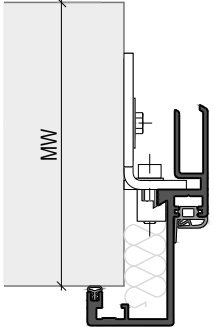
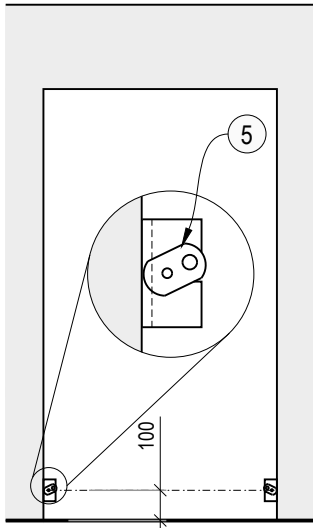
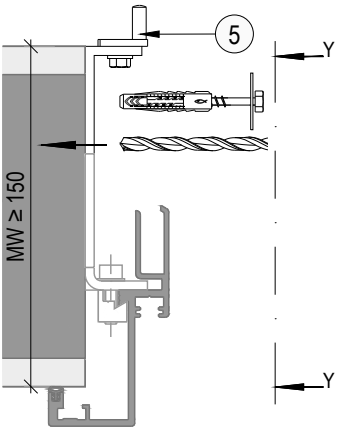
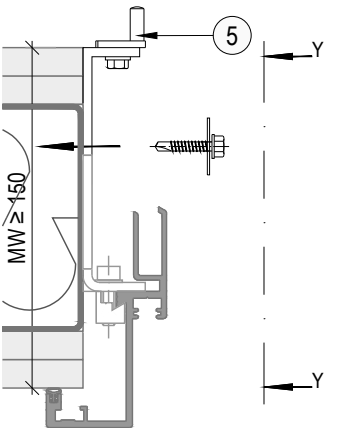
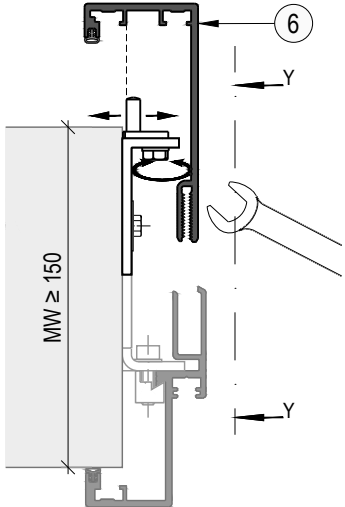
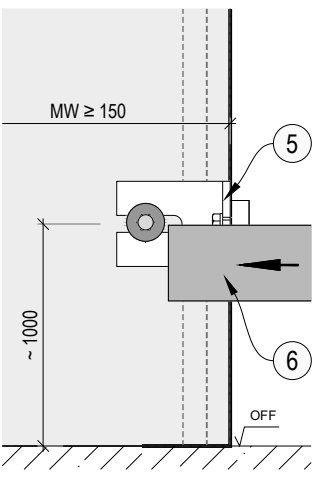
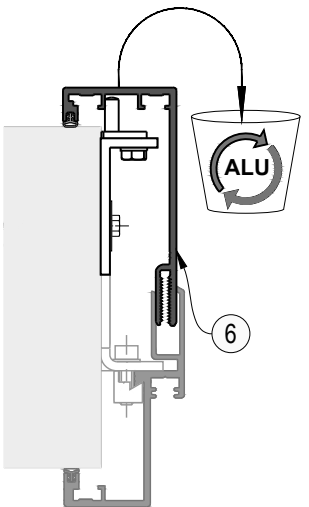
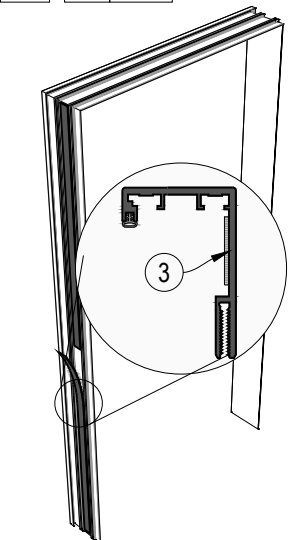
<p>21 3D PUR</p> 	<p>22 3D PUR ≥ 37dB RwP</p> 	<p>MW ≥ 150 ► 23 MW < 150 ► 27</p> 	
<p>23 3D PUR</p> 	<p>24.1 3D PUR Massivwand Solid wall</p> 	<p>24.2 3D PUR Trockenbauwand Drywall</p> 	
<p>25 3D PUR</p> 	<p>Ansicht / View Y - Y</p> 	<p>26 3D PUR</p> 	<p>27 3D PUR</p> 

Einbauanleitung / Mounting Instruction E0-01-03 DE-EN

für Küffner Aluminiumzarge Typ UNF-UST | USTN-UNFN | URS-URF
for Küffner Aluminium Frame Type UNF-UST | USTN-UNFN | URS-URF

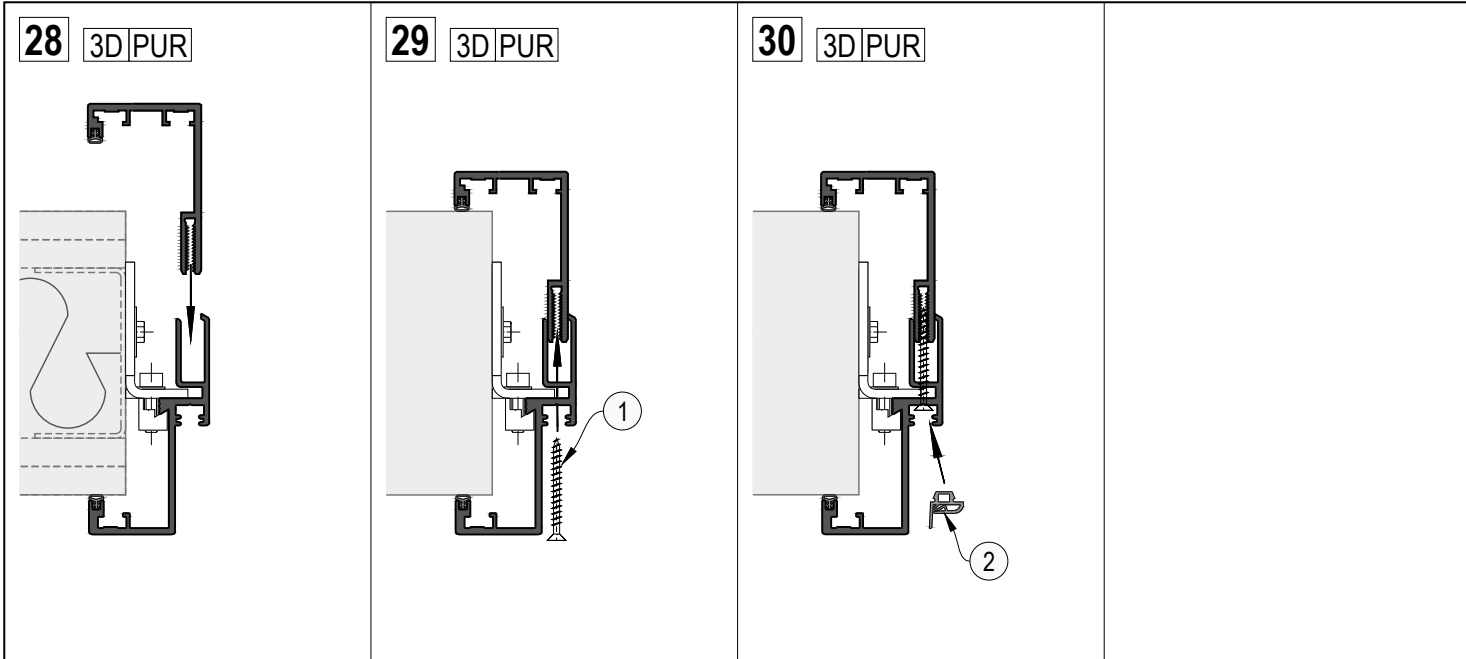

Einbauanleitung / Mounting Instruction E0-01-03 DE-EN

für Küffner Aluminiumzarge Typ UNF-UST | USTN-UNFN | URS-URF
for Küffner Aluminium Frame Type UNF-UST | USTN-UNFN | URS-URF

