

für Typ FZF / FZS / FZDS / FZBS / FZS-V mit CP- oder SL-Band in OSB/ESB-Grundzarge
for Type FZF / FZS / FZDS / FZBS / FZS-V with CP- or SL-Hinge in OSB/ESB-Subframe

FZF30

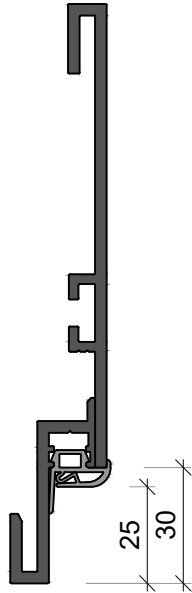

FZS48

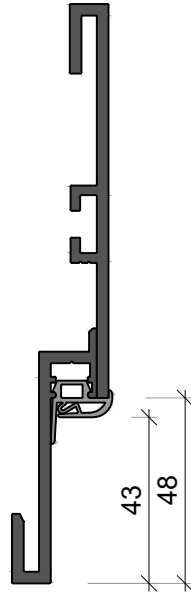

FZS56

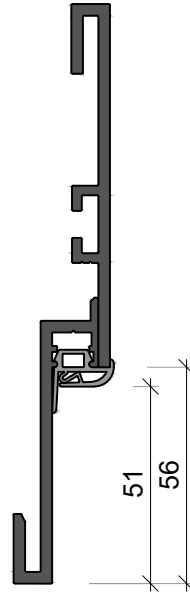

FZDS56

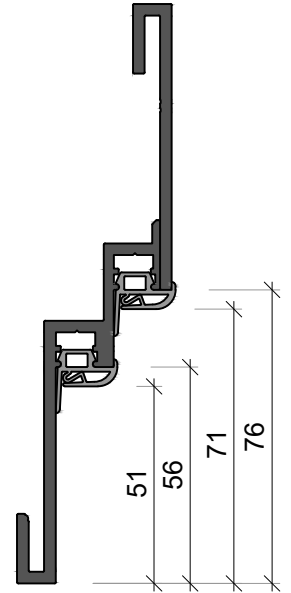

FZBS48

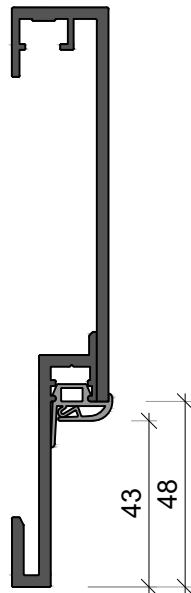

FZBS56

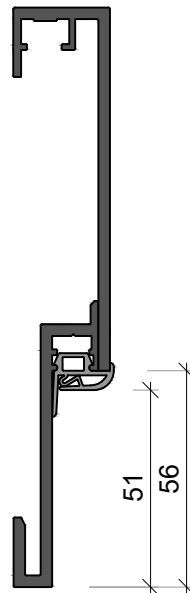

FZS-V
Schiebetür / Sliding Door

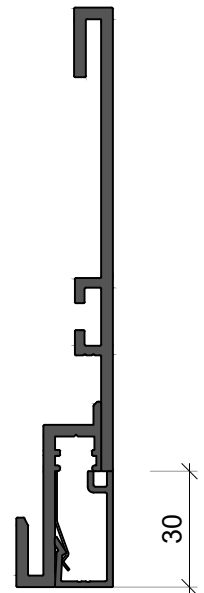

Einbauanleitung / Mounting Instruction E0-03-1 DE/EN

für Typ FZF / FZS / FZDS / FZBS / FZS-V mit CP- oder SL-Band in OSB/ESB-Grundzarge
for Type FZF / FZS / FZDS / FZBS / FZS-V with CP- or SL-Hinge in OSB/ESB-Subframe

FZS Bandkante | Hinge Side

z.B. mit CP - oder SL - Band
e.g. with CP - or SL - Hinge

FZDS Bandkante | Hinge Side

z.B. mit CP - oder SL - Band
e.g. with CP - or SL - Hinge

FZBS Bandkante | Hinge Side

z.B. mit CP - oder SL - Band
e.g. with CP - or SL - Hinge

FZS Schlosskante | Lock Side

PA

wenn / if PA > 145mm

1A 4x

wenn / if PA > 145mm

1B

2 ≥ 11x 4.2x16

3 ≥ 5.5m

4 wenn CP - Band if CP - Hinge

	10x M5x8		20x M5x8		15x M5x8		30x M5x8
--	----------	--	----------	--	----------	--	----------

5 1x 200x50

6A bauseits z.B. 4x20 | on site e.g. 4x20

6B bauseits z.B. 4x35 | on site e.g. 4x35

7 Spanplattenschraube bauseits z.B. 5x30 mit Unterlegscheibe
Chipboard Screw on site e.g. 5x30 with washer

8 Spanplattenschraube bauseits z.B. 5x35 Chipboard Screw
on site e.g. 5x35

für Typ FZF / FZS / FZDS / FZBS / FZS-V mit CP- oder SL-Band in OSB/ESB-Grundzarge
for Type FZF / FZS / FZDS / FZBS / FZS-V with CP- or SL-Hinge in OSB/ESB-Subframe

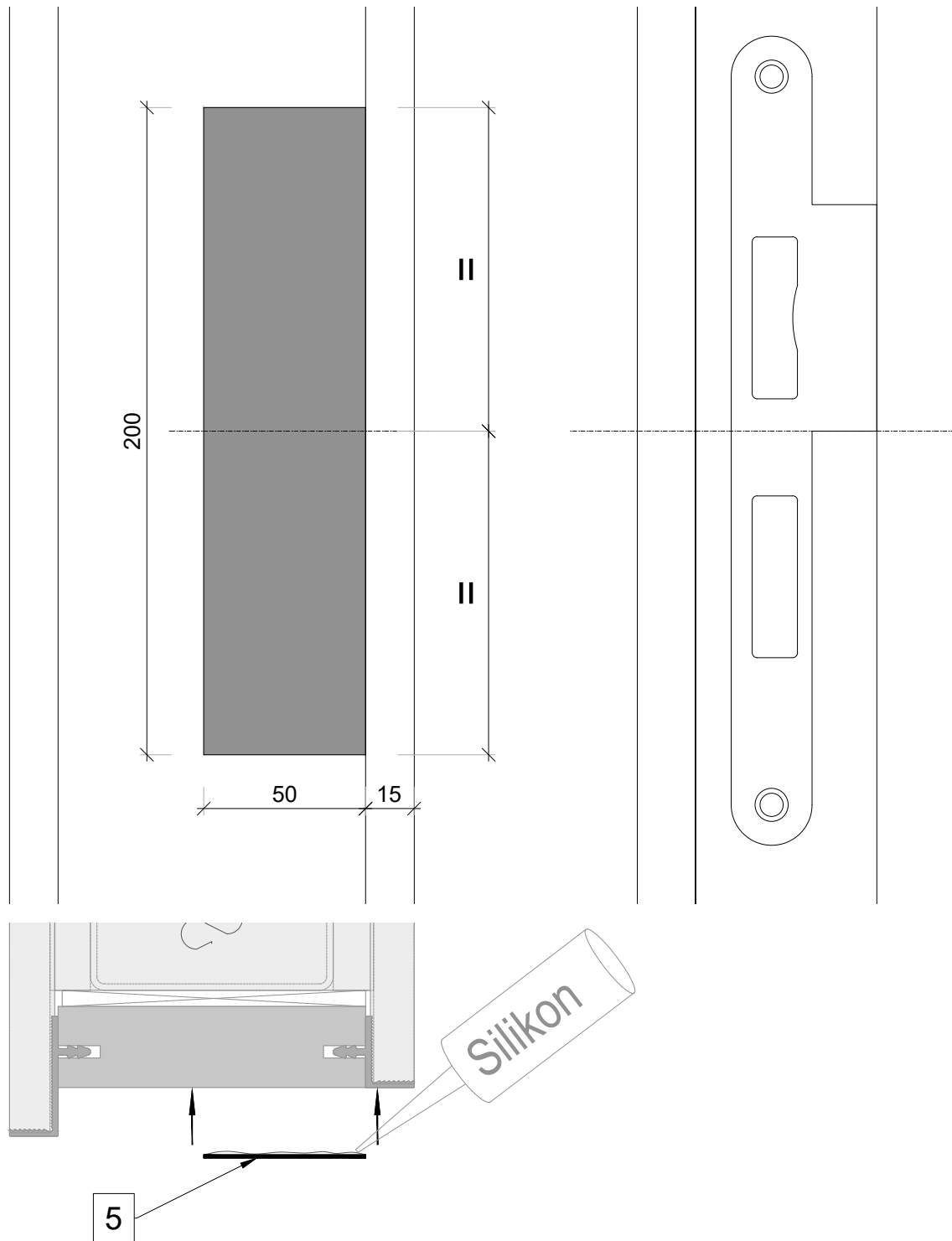

für Typ FZF / FZS / FZDS / FZBS / FZS-V mit CP- oder SL-Band in OSB/ESB-Grundzarge
for Type FZF / FZS / FZDS / FZBS / FZS-V with CP- or SL-Hinge in OSB/ESB-Subframe

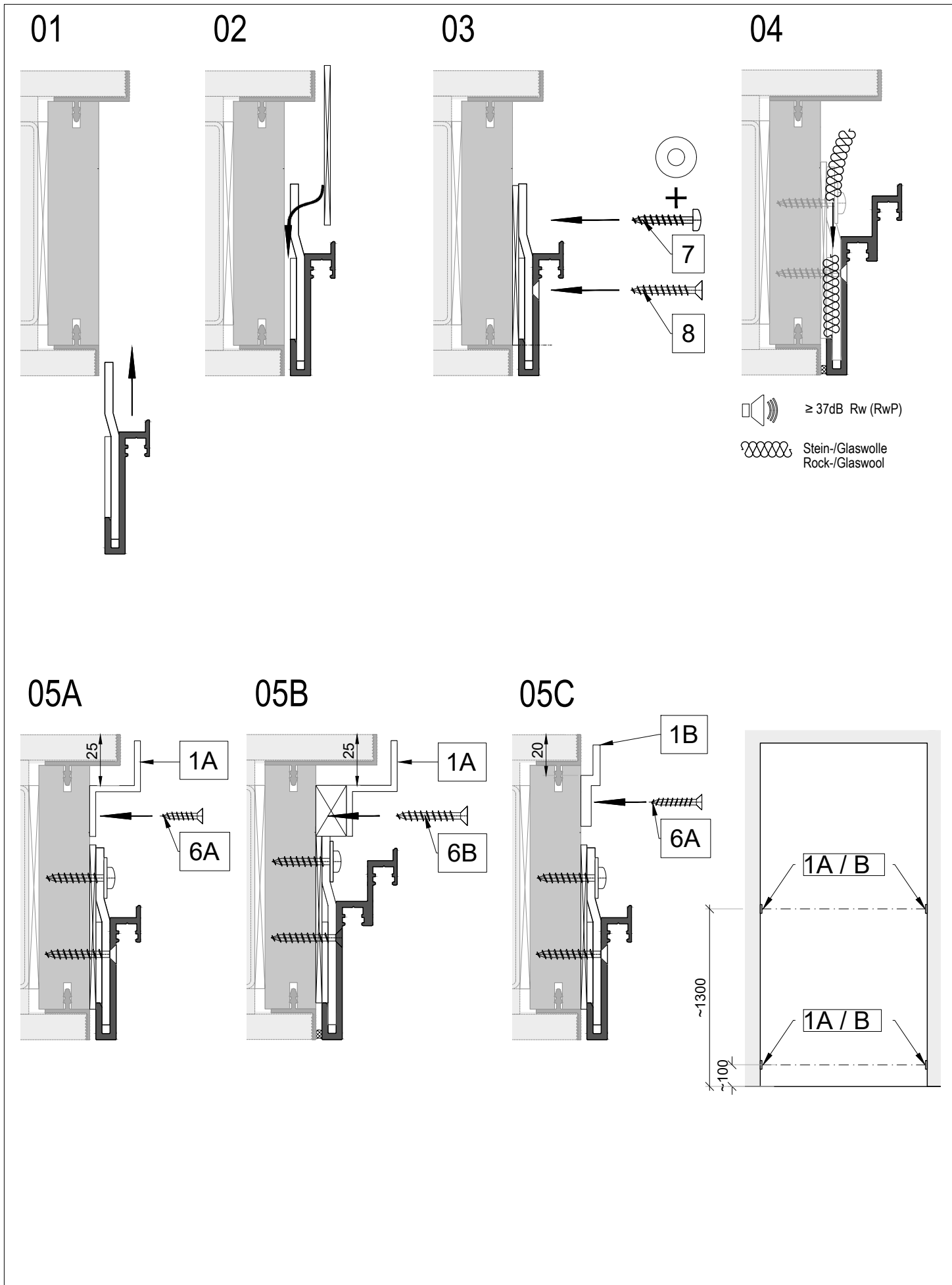

für Typ FZF / FZS / FZDS / FZBS / FZS-V mit CP- oder SL-Band in OSB/ESB-Grundzarge
for Type FZF / FZS / FZDS / FZBS / FZS-V with CP- or SL-Hinge in OSB/ESB-Subframe

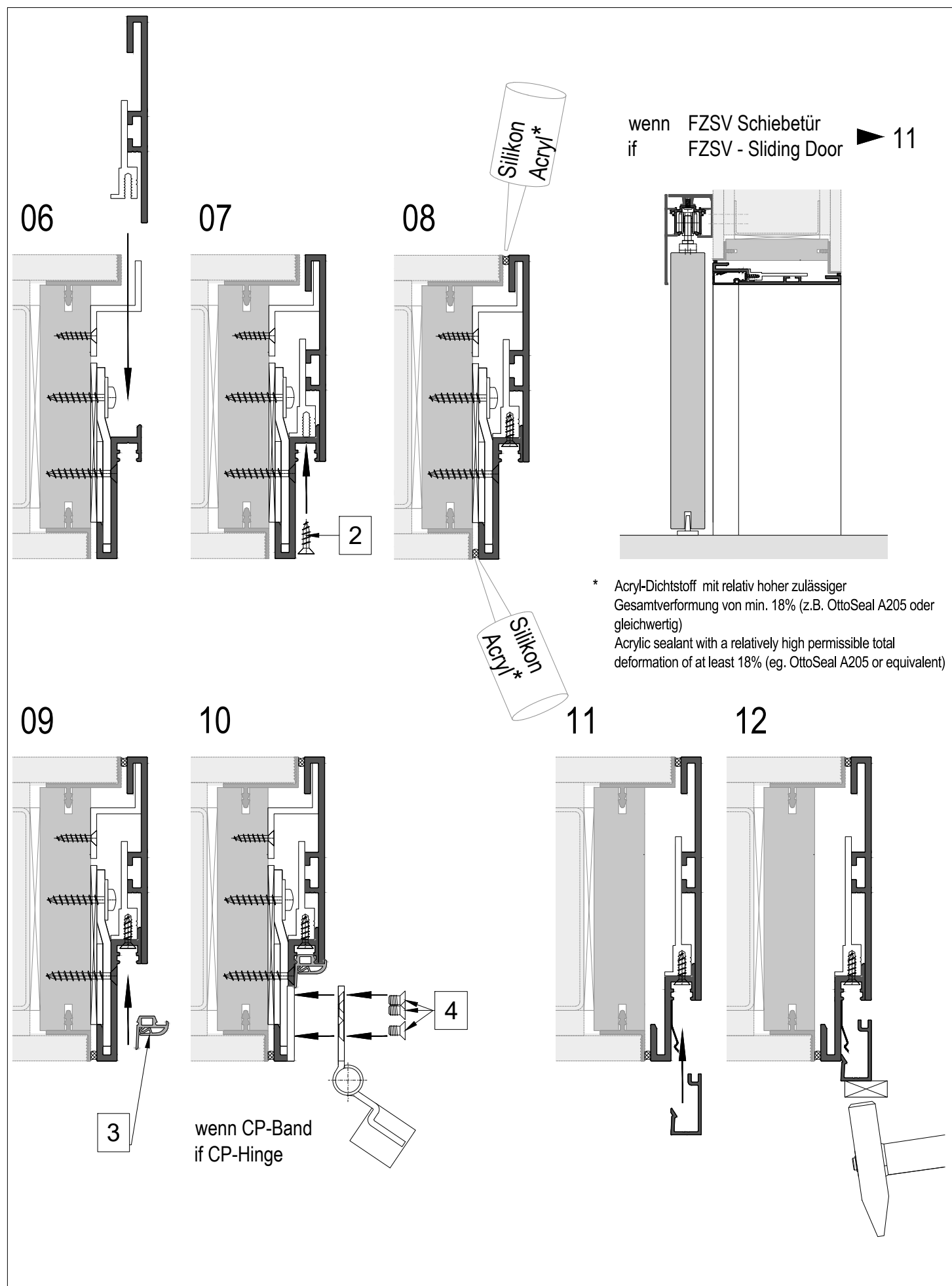

Festverglasungen / Fixed Glazing:

13

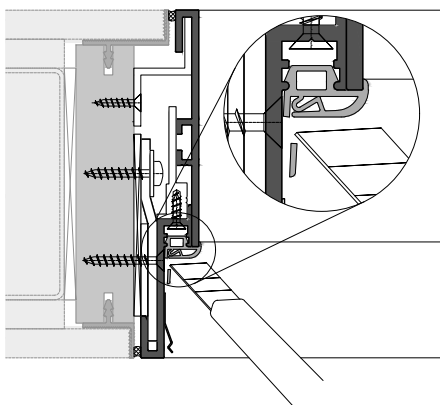

Im Bereich der Verklebung
In the field of bonding

14

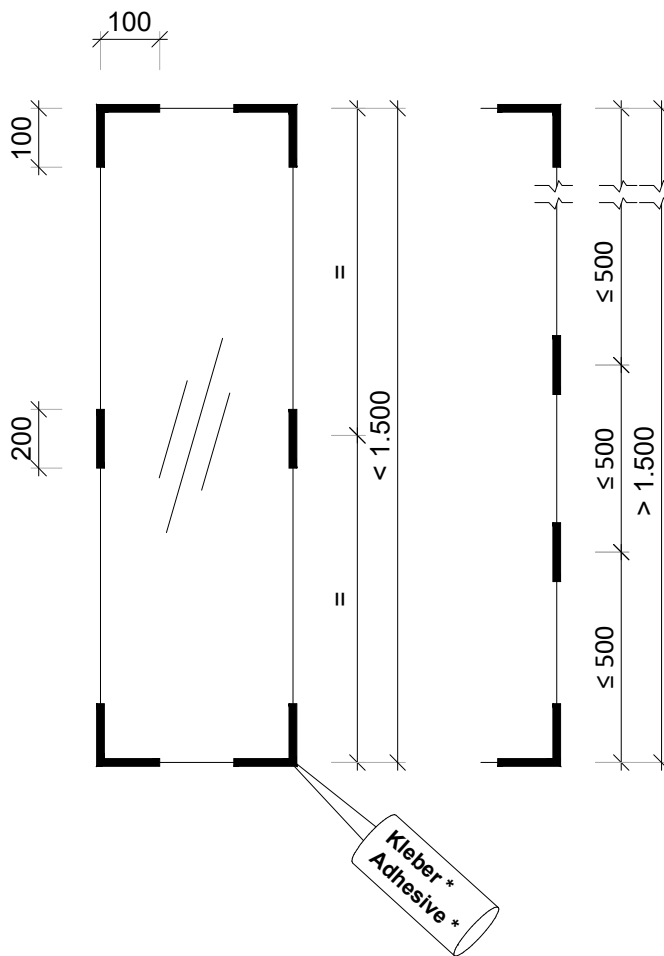
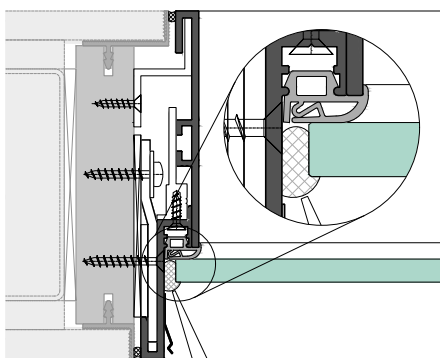

* Kleb-/ Dichtungsmasse Typ 2H HB45 von HELLER auf Hybridpolymerbasis oder gleichwertig.
Die technischen Angaben des Kleb-/ Dichtungsmassenherstellers sind zu beachten.

Adhesive / sealant Type 2H HB 45 from HELLER based on Hybrid Polymer or equivalent. The technical data of the adhesive / sealant manufacturer must be considered.

15

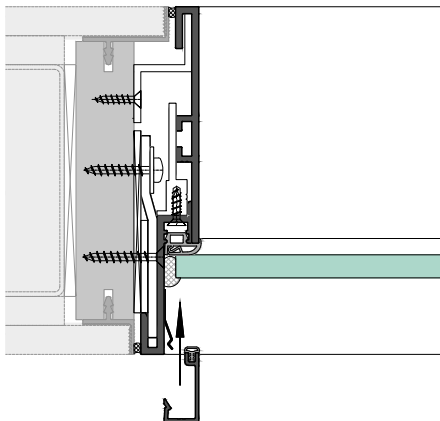

16

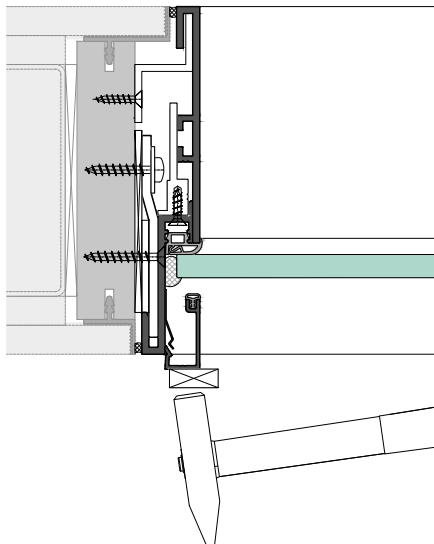

17

