

für Typ LZS und LZDS mit CP-Band
for Type LZS and LZDS with CP-Hinge

LZS
mit Küffner CP - Band
with Küffner CP - Hinge

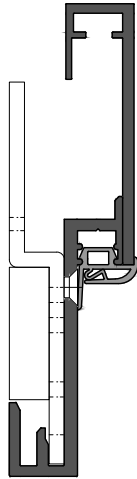

LZDS
mit Küffner CP - Band
with Küffner CP - Hinge

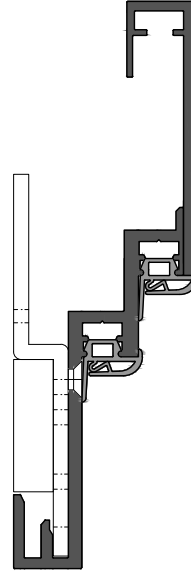

für Typ LZS und LZDS mit CP-Band
for Type LZS and LZDS with CP-Hinge

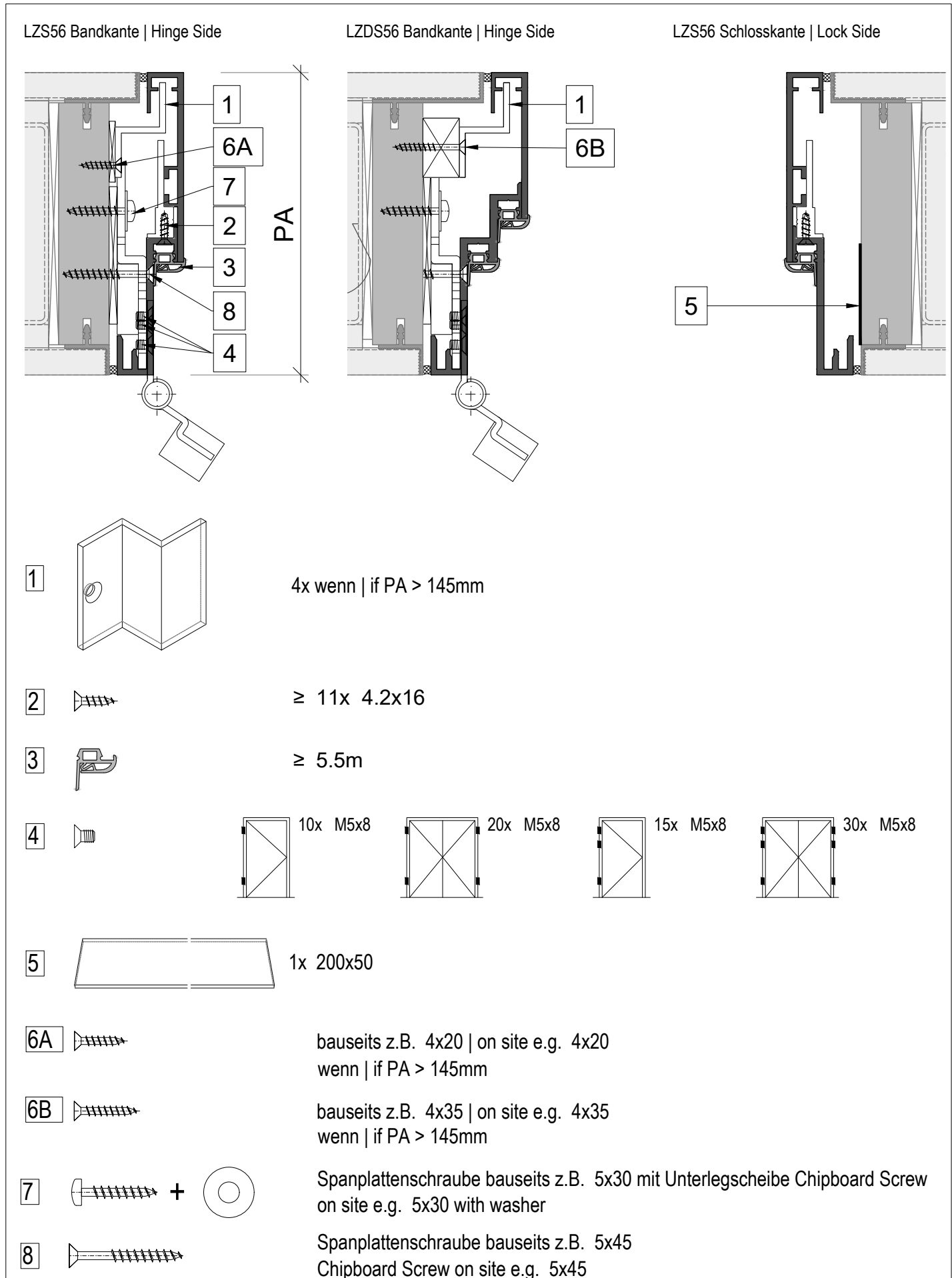

für Typ LZS und LZDS mit CP-Band
for Type LZS and LZDS with CP-Hinge

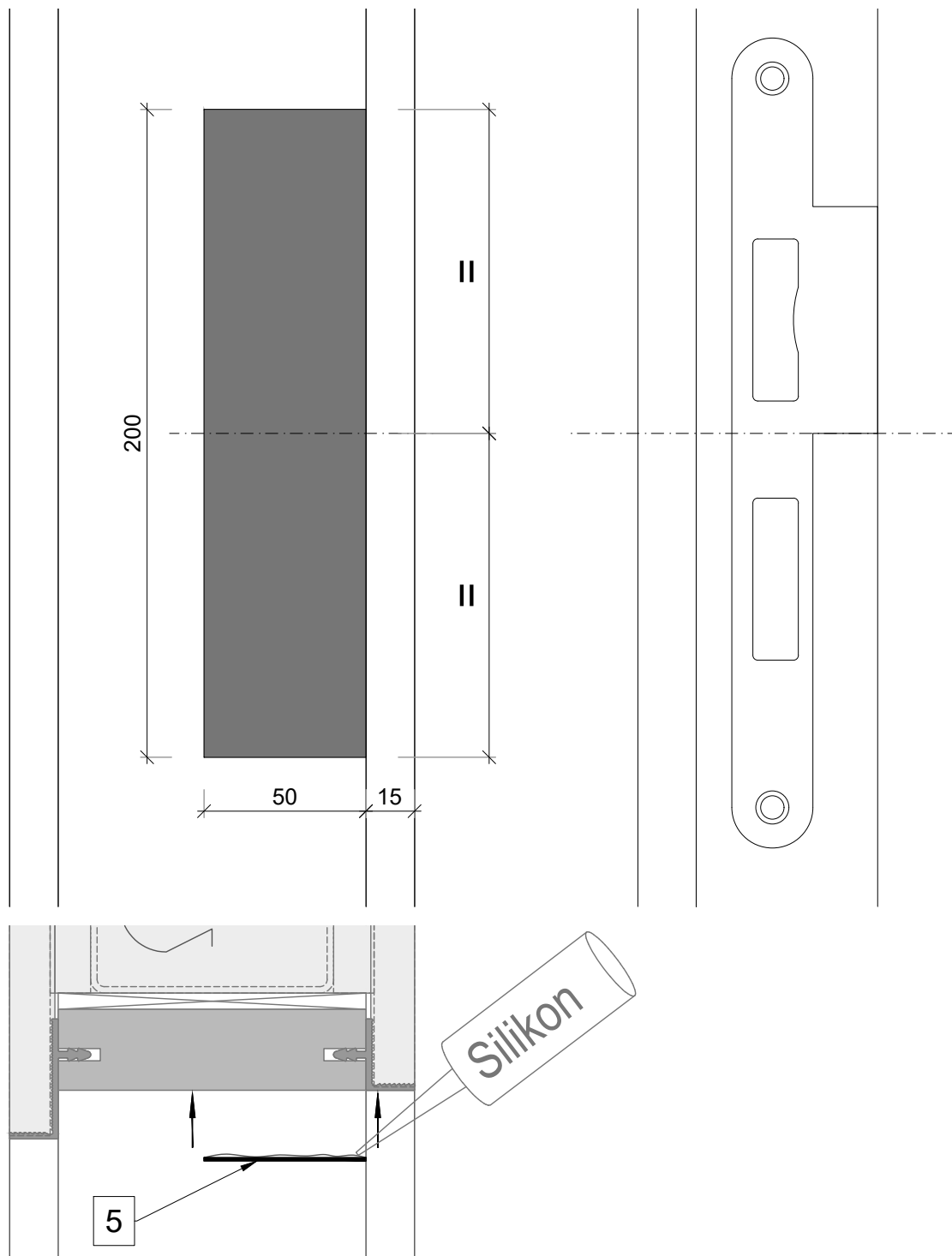

für Typ LZS und LZDS mit CP-Band
for Type LZS and LZDS with CP-Hinge

01

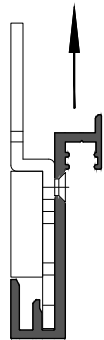
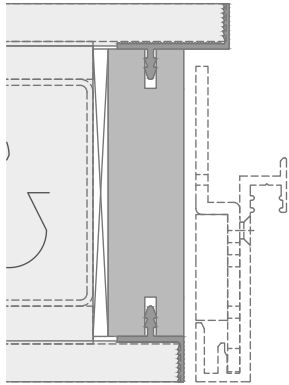

02

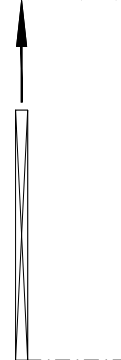
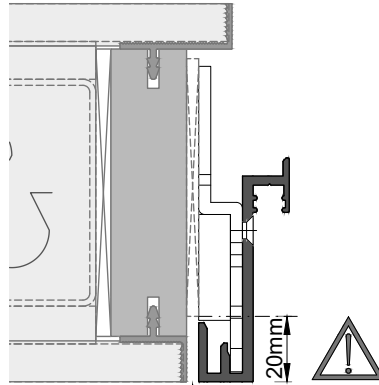

03

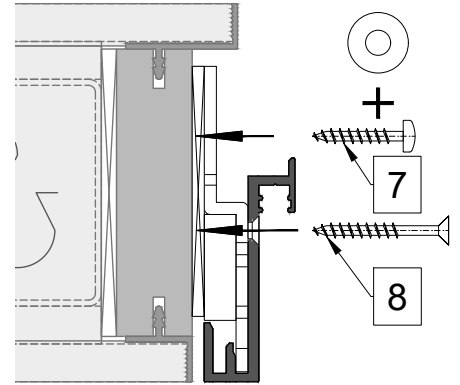

04

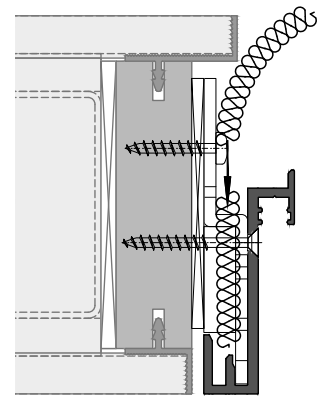

≥ 37dB RwP

05A

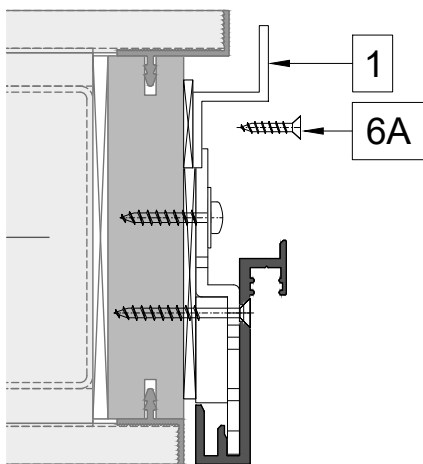

05B

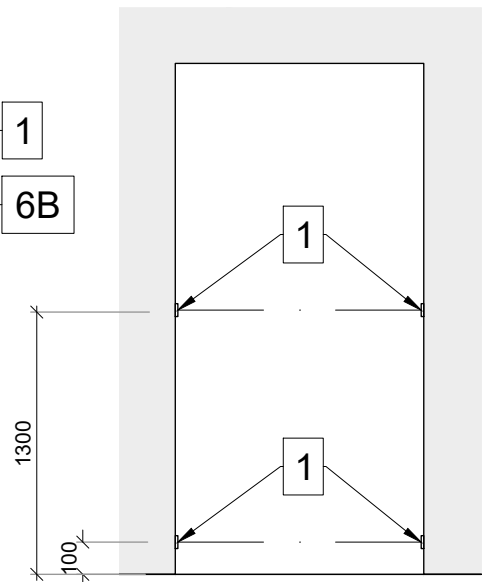
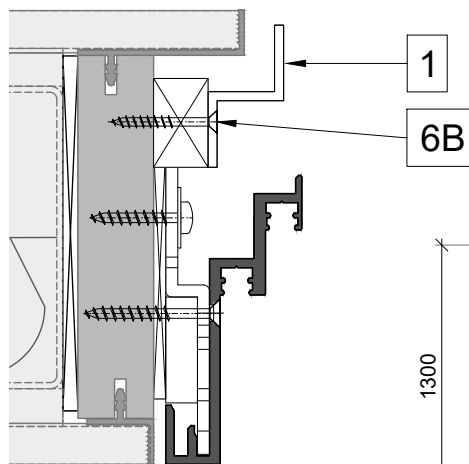

für Typ LZS und LZDS mit CP-Band
for Type LZS and LZDS with CP-Hinge

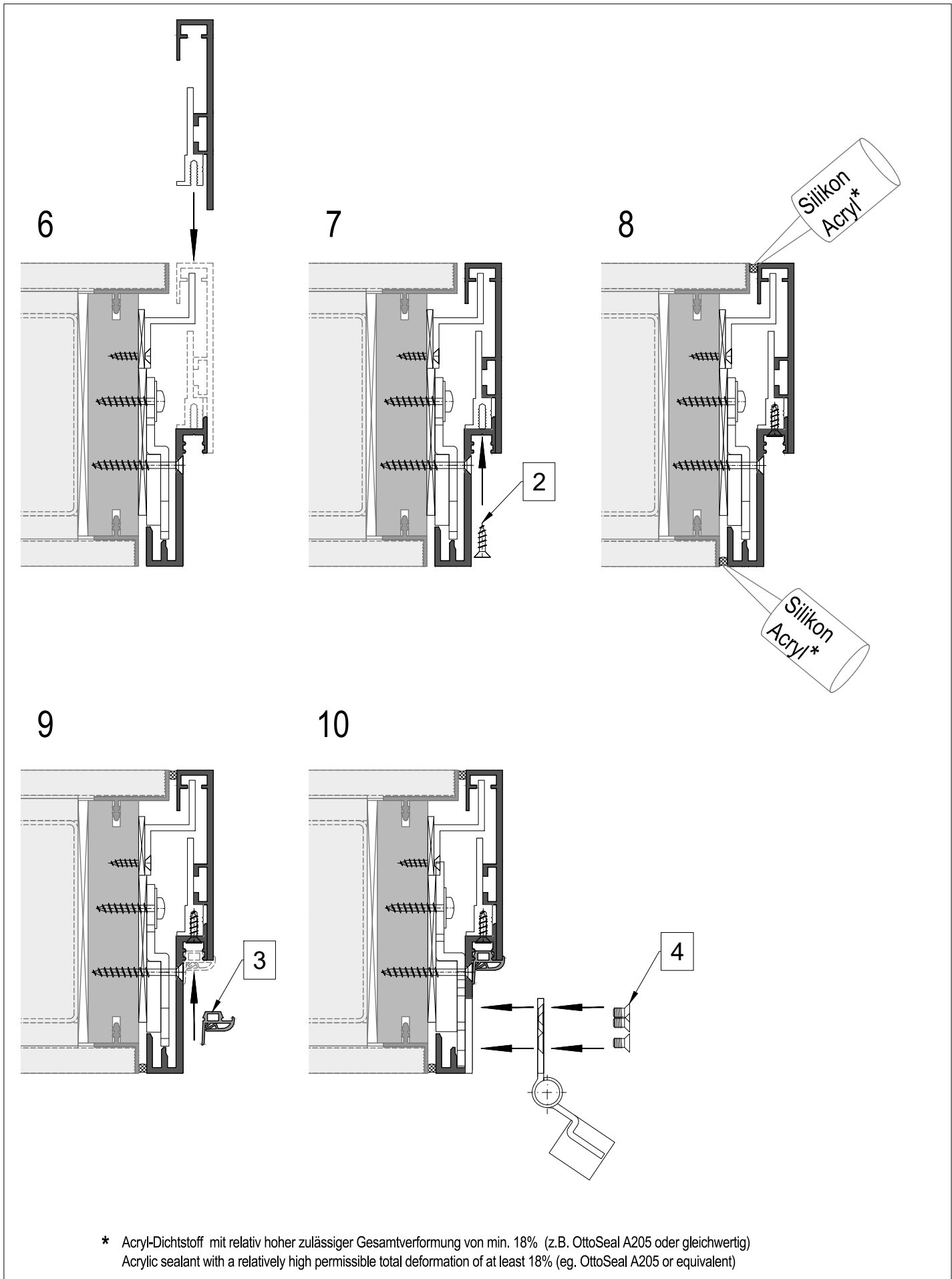

für Typ LZS und LZDS mit CP-Band
for Type LZS and LZDS with CP-Hinge

Festverglasungen / Fixed Glazing:

11

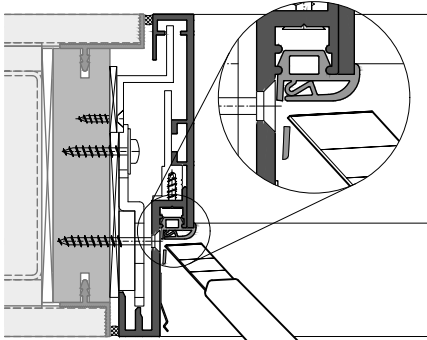

Im Bereich der Verklebung
In the field of bonding

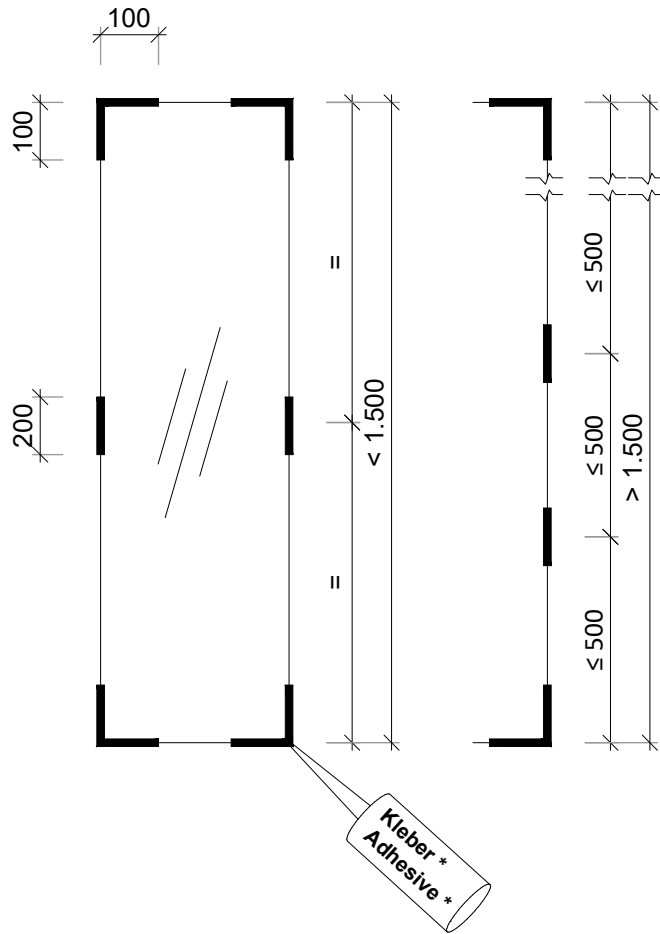

12

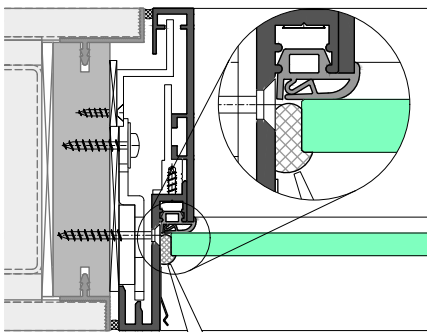

* Kleb-/ Dichtungsmasse Typ 2H HB45 von HELLER auf Hybridpolymerbasis oder gleichwertig. Die technischen Angaben des Kleb-/ Dichtungsmassenherstellers sind zu beachten.

Adhesive / sealant Type 2H HB 45 from HELLER based on Hybrid Polymer or equivalent. The technical data of the adhesive / sealant manufacturer must be considered.

13

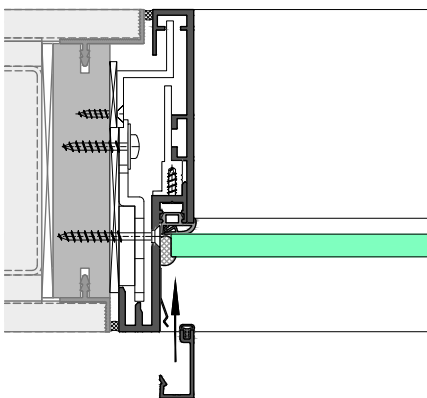

14

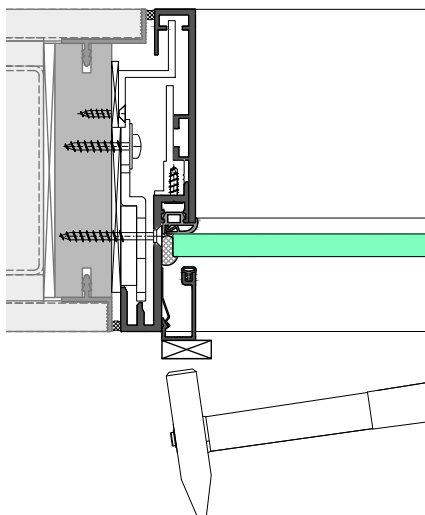

15

